



Non-exhibition events
and conference halls



Table of contents

Non-exhibition events.....2

Conference halls description.....5

Significant events16

Contacts.....20

Non-exhibition events



Crocus Expo offers exhibition halls, conference halls and outdoor area across from the pavilions for holding non-exhibition events (congresses, business forums, conferences, seminars, meetings, sessions, presentations, training courses, spectacular sports events etc.).

Crocus Expo exhibition halls offer the perfect platform for holding corporate events, concerts, shows of any scale and format.

Outdoor area can be used for test drive arrangements, festivals holding, video shooting and other public events any season regardless of weather conditions.



Non-exhibition events



16 conference halls ranging from 50 and up to 775 square meters are offered for holding congresses, business forums, conferences, seminars, meetings, sessions, presentations and training courses:

- two conference halls each of 600 amphitheater seating capacity (Blue and Red) facilitated with stationary stages (Pavilion 2);
- 14 conference halls and 9 meeting rooms adjoining exhibition halls;
- VIP area (Pavilion 1).



Non-exhibition events

A wide range of services is offered for event organizers:



Rent of audio, video, presentation equipment and projectors

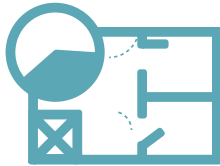

Space buildup and decoration

Security services



Accommodation in the hotel

Advertising opportunities

Conference halls and meeting rooms Pavilion 1

Conference halls and meeting rooms description and specification

Conference halls	Space, sq m	Ceiling height, m	Seating capacity (amphitheater seating)
A	166	3,87	150
B	85	3,87	70
C	142	3,87	130
D	110	3,87	100
E	257	3,87	250
F	300	3,87	300
G	300	3,87	300
F+G	600	3,87	600
Meeting room 1	28	3,87	10
Meeting room 2	28	3,87	10
Meeting room 3	26	3,87	10
Meeting room 4	25	3,87	10
VIP area	575	5,35	64

General layout

7 conference halls and 4 meeting rooms

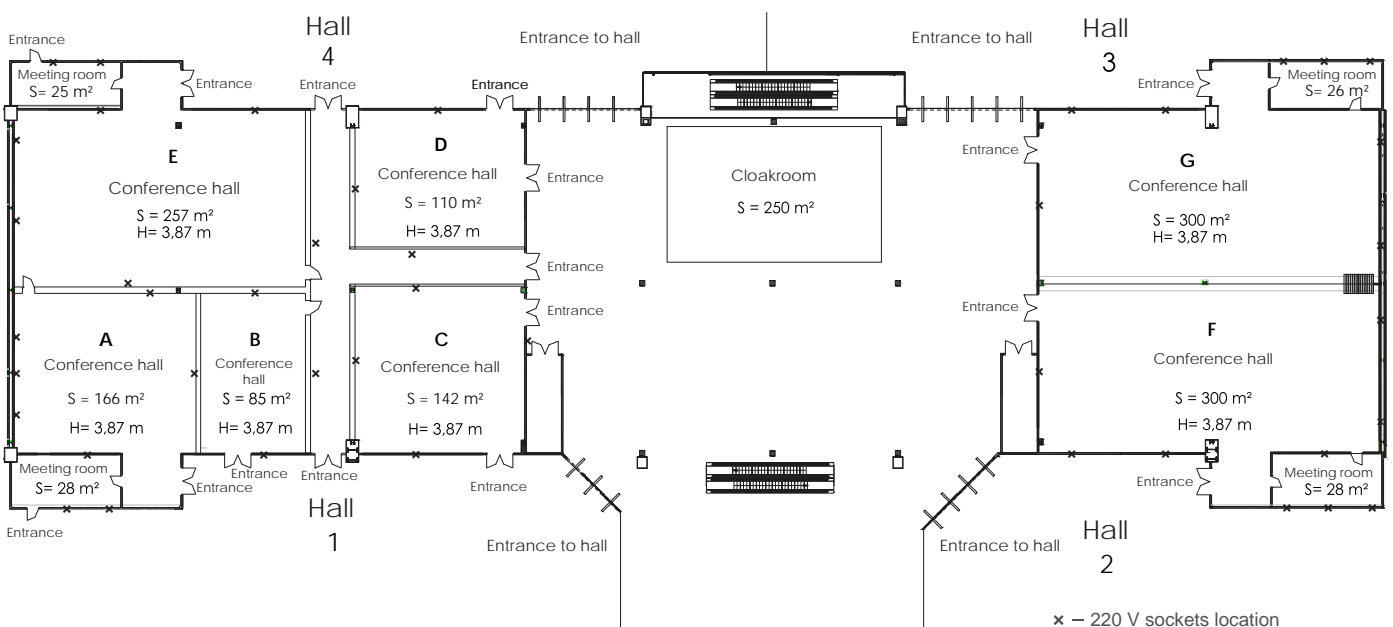

Conference halls layout and specification, Pavilion 1

Conference hall A

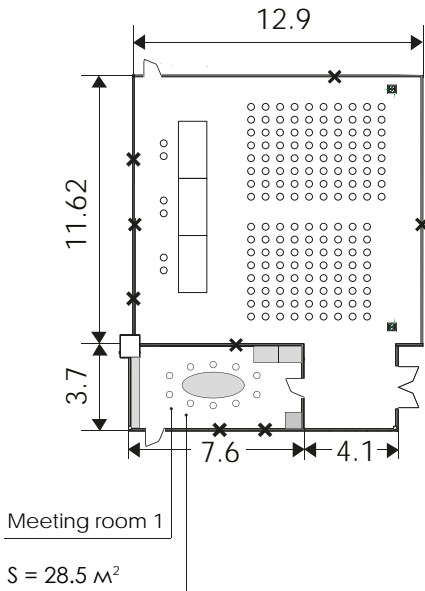

Seating capacity – 150
S = 166 m²

Ceiling height – 3.87 m
Presidium table – 1.49 x 0.75 x 0.74 (L x W x H)
x – 220 V sockets location

Conference hall B

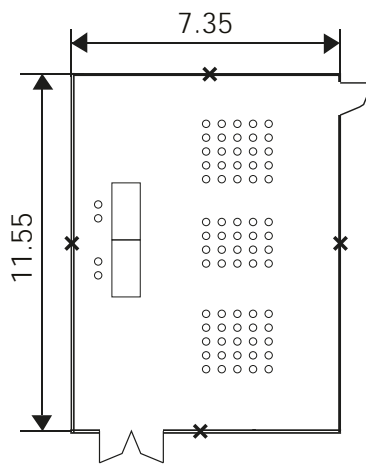

Seating capacity – 70
S = 85 m²

Ceiling height – 3.87 m
Presidium table – 1.49 x 0.75 x 0.74 (L x W x H)
x – 220 V sockets location

Conference hall C

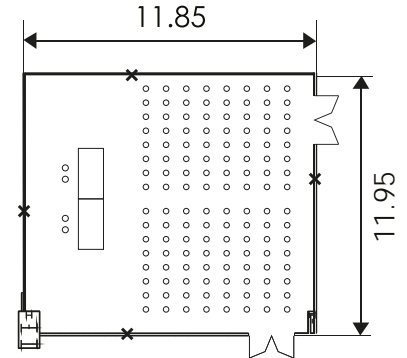

Seating capacity – 130
S = 142 m²

Ceiling height – 3.87 m
Presidium table – 1.49 x 0.75 x 0.74 (L x W x H)
x – 220 V sockets location

Conference hall D

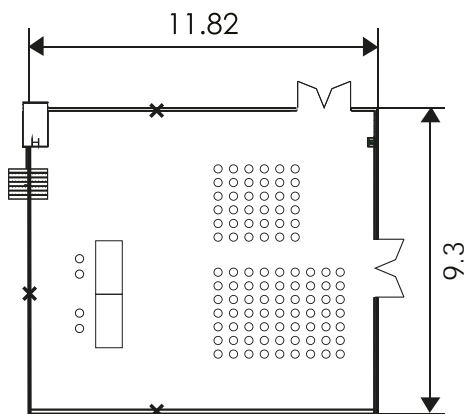

Seating capacity – 100
S = 110 m²

Ceiling height – 3.87 m
Presidium table – 1.49 x 0.75 x 0.74 (L x W x H)
x – 220 V sockets location

Conference hall E

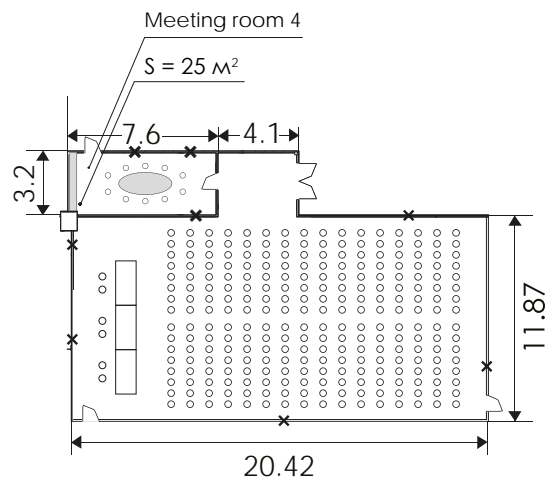

Seating capacity – 250
S = 257 m²

Ceiling height – 3.87 m
Presidium table – 1.49 x 0.75 x 0.74 (L x W x H)
x – 220 V sockets location

Conference halls layout and specification, Pavilion 1

Conference hall F+G

Seating capacity – 600
S = 600 m²

Ceiling height – 3.87 m

Presidium table – 1.49 x 0.75 x 0.74 (L x W x H)

x – 220 V sockets location

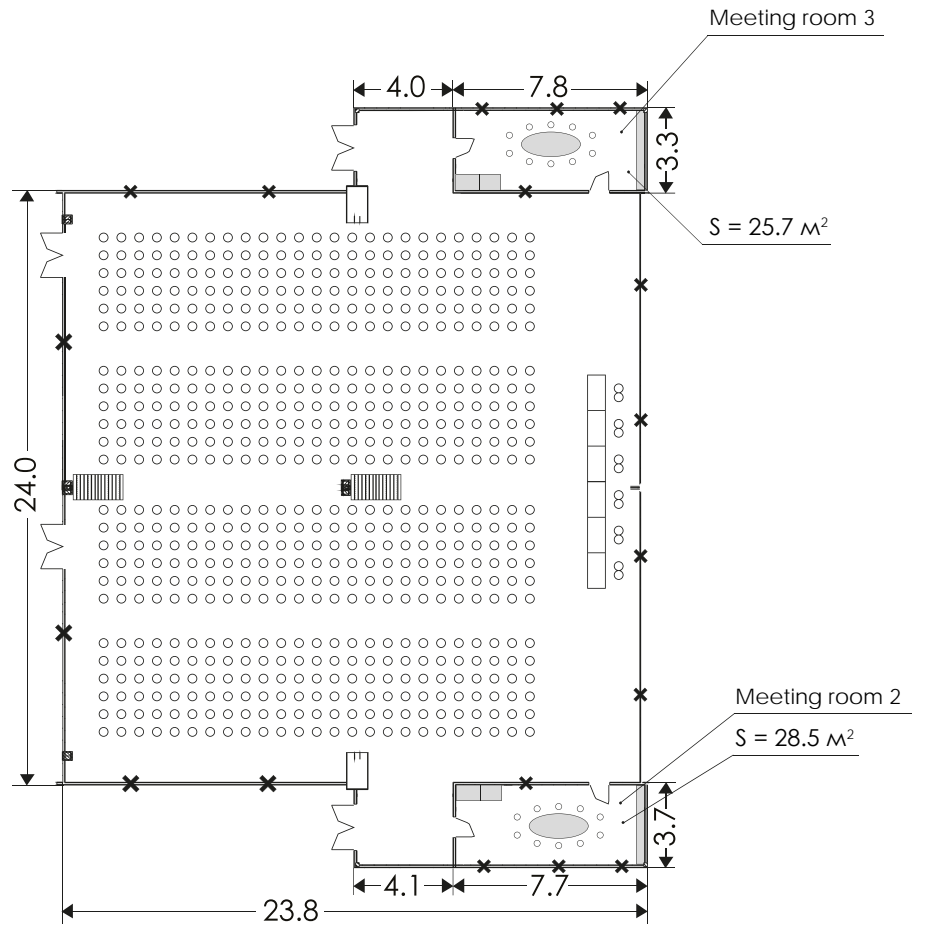

Conference hall F

Conference hall G

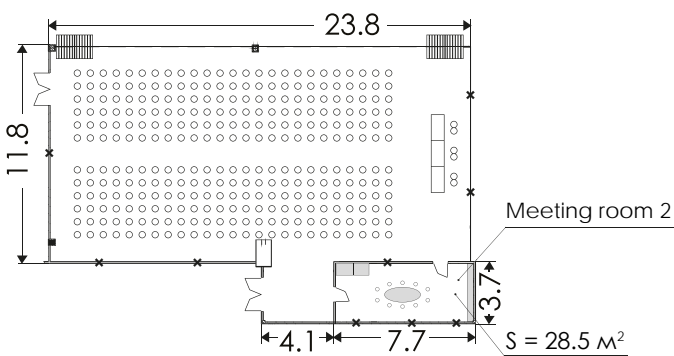

Seating capacity – 300
S = 300 m²

Ceiling height – 3.87 m

Presidium table – 1.49 x 0.75 x 0.74 (L x W x H)

x – 220 V sockets location

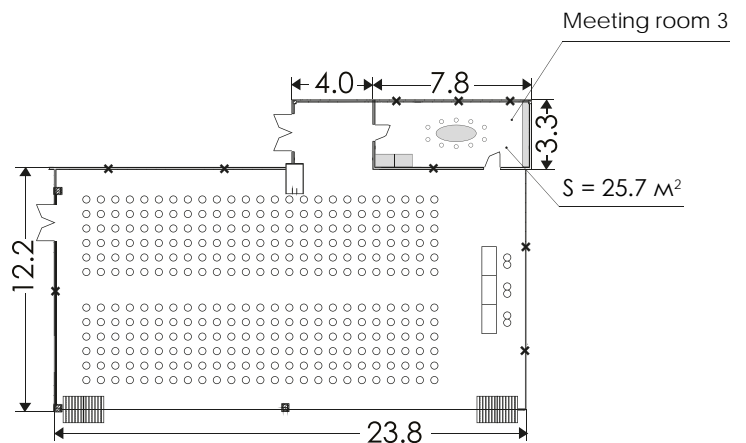

Seating capacity – 300
S = 300 m²

Ceiling height – 3.87 m

Presidium table – 1.49 x 0.75 x 0.74 (L x W x H)

x – 220 V sockets location

Meeting rooms layout and specification, Pavilion 1

Meeting room 1

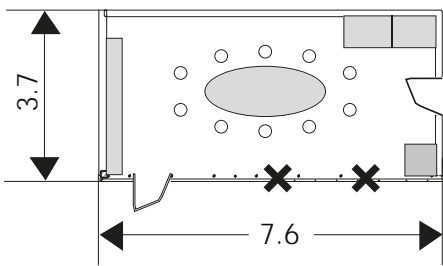

Seating capacity – 10

S = 28 m²

Ceiling height – 3.87 m

x – 220 V sockets location

Meeting room 2

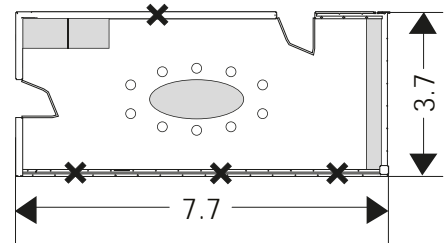

Seating capacity – 10

S = 28 m²

Ceiling height – 3.87 m

x – 220 V sockets location

Meeting room 3

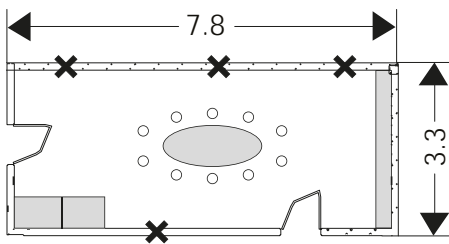

Seating capacity – 10

S = 26 m²

Ceiling height – 3.87 m

x – 220 V sockets location

Meeting room 4

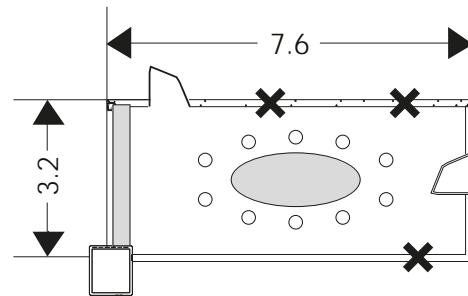

Seating capacity – 10

S = 25 m²

Ceiling height – 3.87 m

x – 220 V sockets location

VIP area layout and specification, Pavilion 1

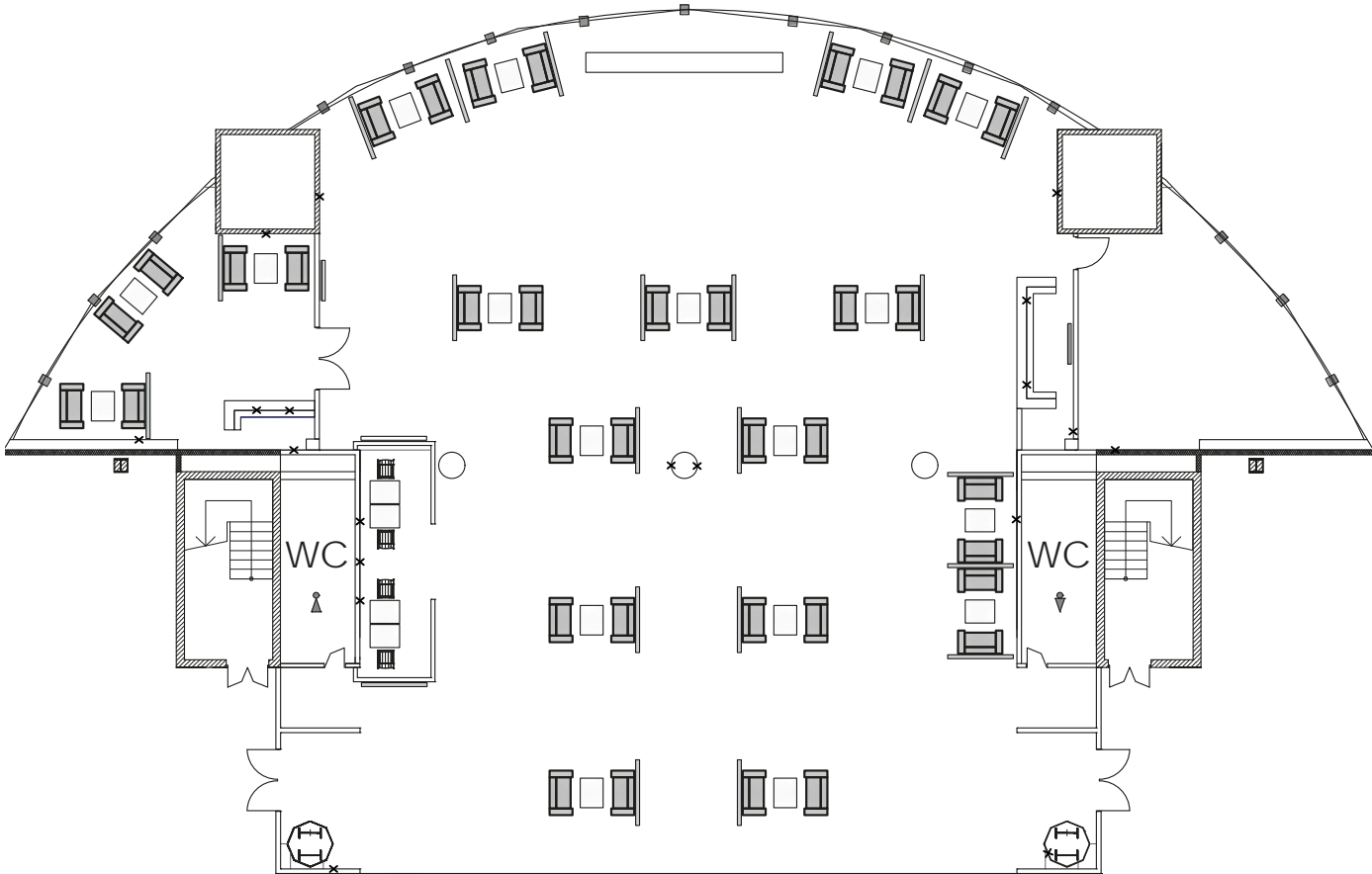

Seating capacity – 64

S = 575 m²

Ceiling height – 5.35 m

x – 220 V sockets location

Conference halls and meeting rooms Pavilion 2

Conference halls and meeting rooms description and specification

Conference halls	Space, sq m	Ceiling height, m	Seating capacity (amphitheater seating)
H	286	3,71	300
J	98	3,71	80
K	94	3,71	90
L	127,6	3,71	120
M	67,3	3,71	70
N	67,3	3,71	70
P	54	3,71	50
Meeting room 5	30	3,71	10
Meeting room 6	24,8	3,71	10
Meeting room 7	22	3,71	10
Meeting room 8	35,8	3,71	16
Meeting room 9	49	3,71	18
Red (amphitheater with a stationary stage)	775	from 1,76 to 7,57	600
Blue (amphitheater with a stationary stage)	775	from 1,83 to 7,47	600

General layout

7 conference halls and 5 meeting rooms

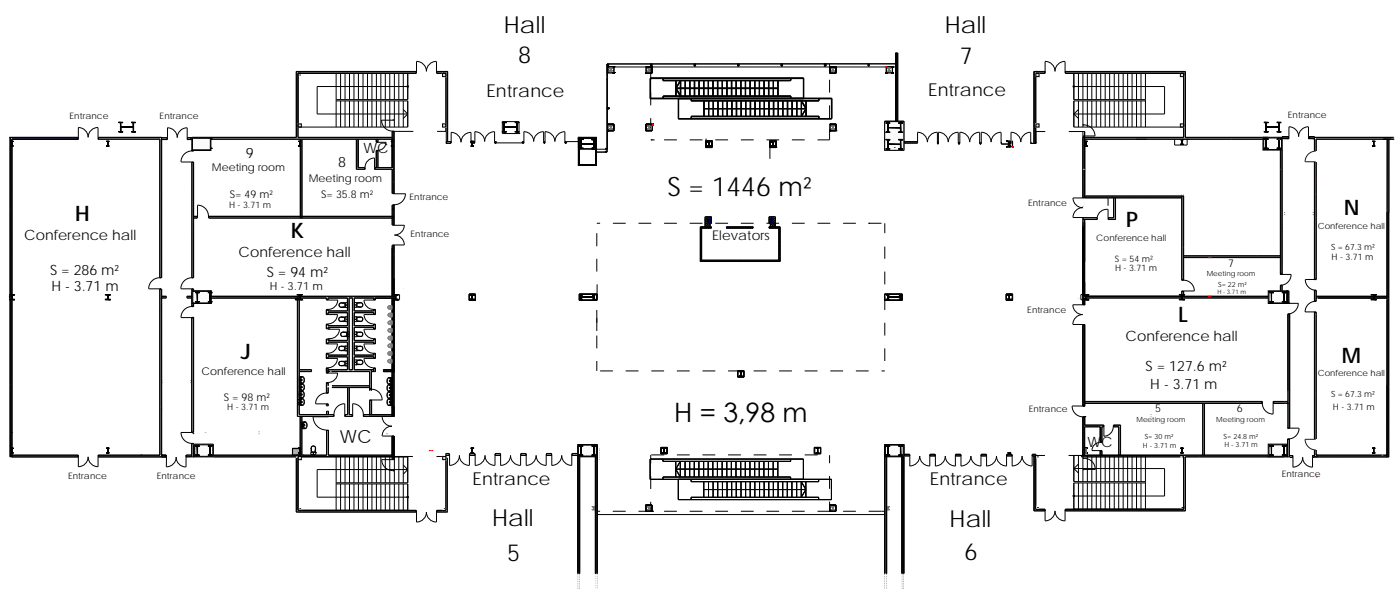

Conference halls layout and specification, Pavilion 2

Conference hall H

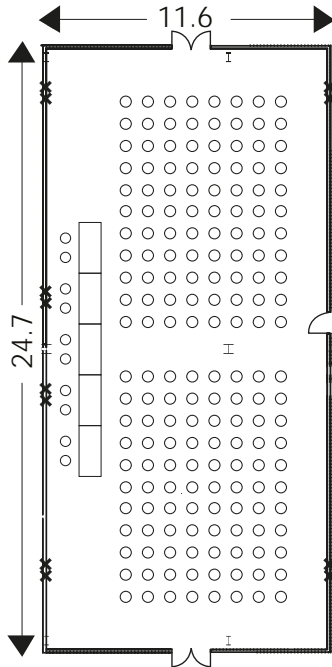

Seating capacity – 300
S = 286 m²

Ceiling height – 3.71 m

Presidium table – 1.49 x 0.75 x 0.74 (L x W x H)

x – 220 V sockets location

Conference hall J

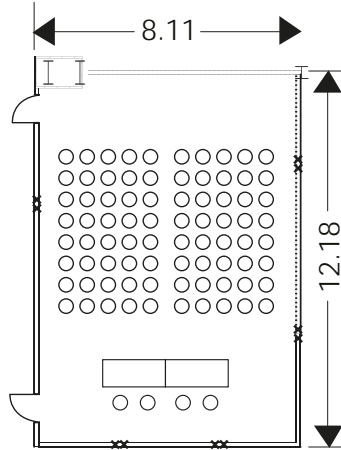

Seating capacity – 80
S = 98 m²

Ceiling height – 3.71 m

Presidium table – 1.49 x 0.75 x 0.74 (L x W x H)

x – 220 V sockets location

Conference hall K

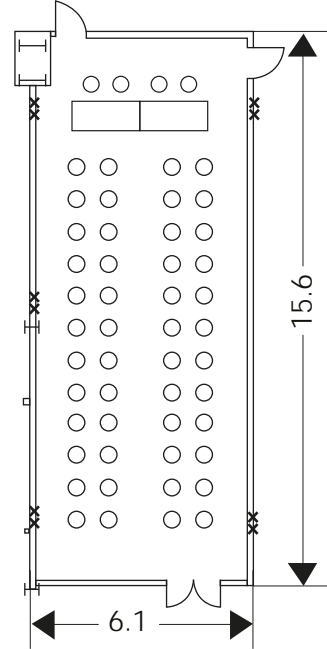

Seating capacity – 90
S = 94 m²

Ceiling height – 3.71 m

Presidium table – 1.49 x 0.75 x 0.74 (L x W x H)

x – 220 V sockets location

Conference hall L

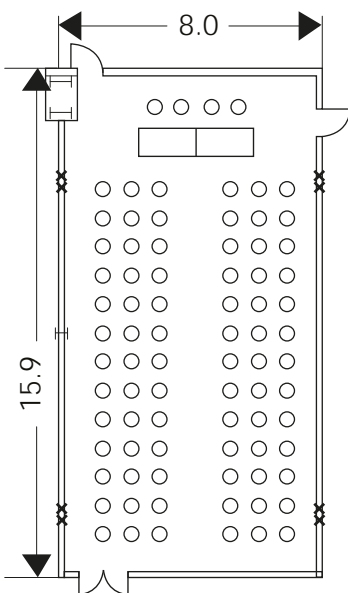

Seating capacity – 120
S = 127.6 m²

Ceiling height – 3.71 m

Presidium table – 1.49 x 0.75 x 0.74 (L x W x H)

x – 220 V sockets location

Conference hall M

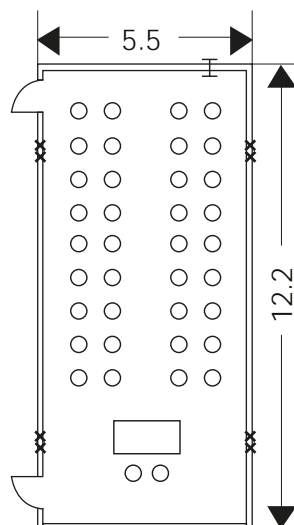

Seating capacity – 70
S = 67.3 m²

Ceiling height – 3.71 m

Presidium table – 1.49 x 0.75 x 0.74 (L x W x H)

x – 220 V sockets location

Conference halls layout and specification, Pavilion 2

Conference hall N

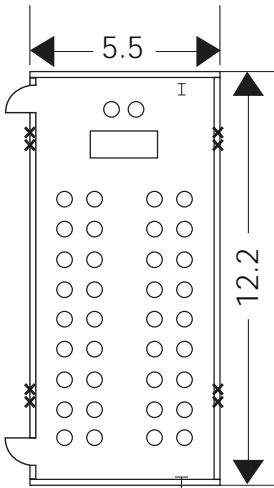

Seating capacity – 70

S = 67.3 m²

Ceiling height – 3.71 m

Presidium table – 1.49 x 0.75 x 0.74 (L x W x H)

x – 220 V sockets location

Conference hall P

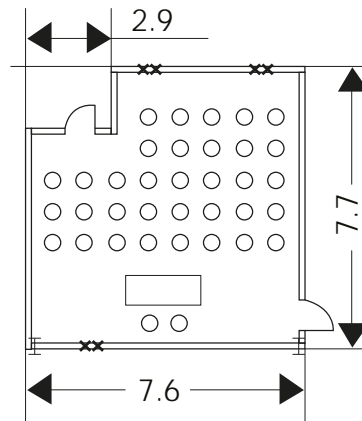

Seating capacity – 50

S = 54 m²

Ceiling height – 3.71 m

Presidium table – 1.49 x 0.75 x 0.74 (L x W x H)

x – 220 V sockets location

Conference halls layout and specification, Pavilion 2

Pavilion 2, floor 3

2 conference halls

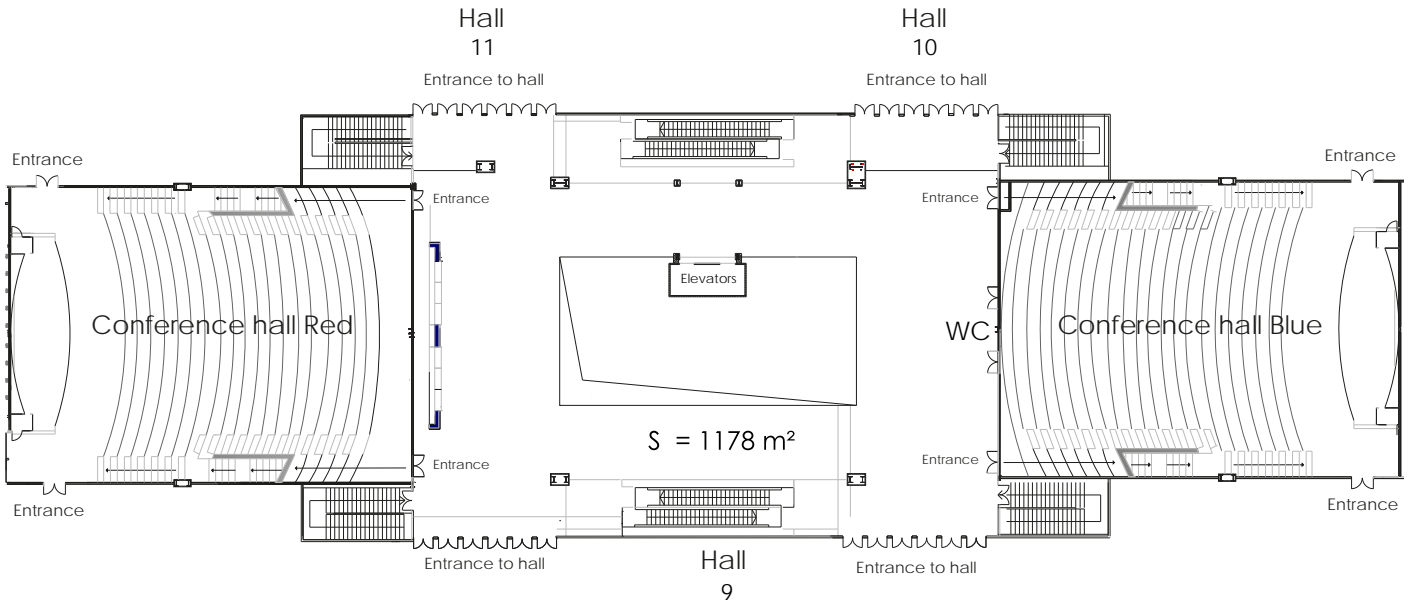

Conference hall Red

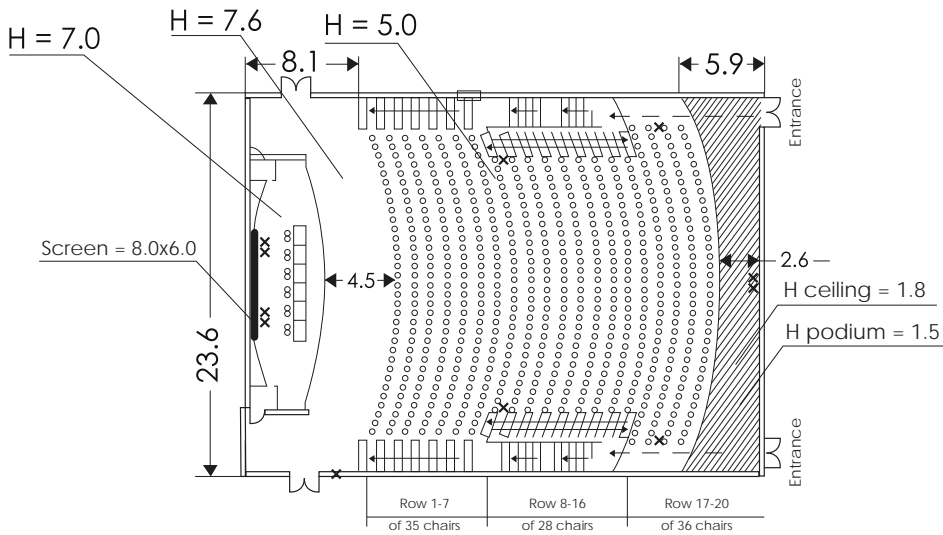

Seating capacity – 600

S = 775 m²

Presidium table – 1.49 x 0.75 x 0.74 (L x W x H)

x – 220 V sockets location

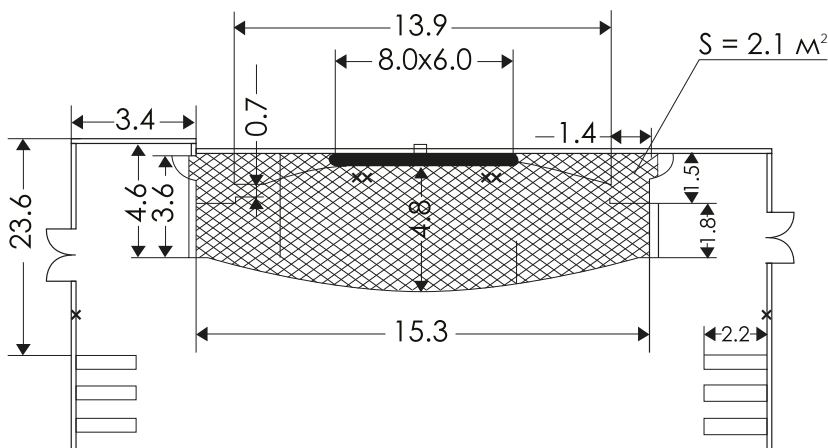

Podium layout conference hall Red

x – 220 V sockets location

Conference halls layout and specification, Pavilion 2

Conference hall Blue

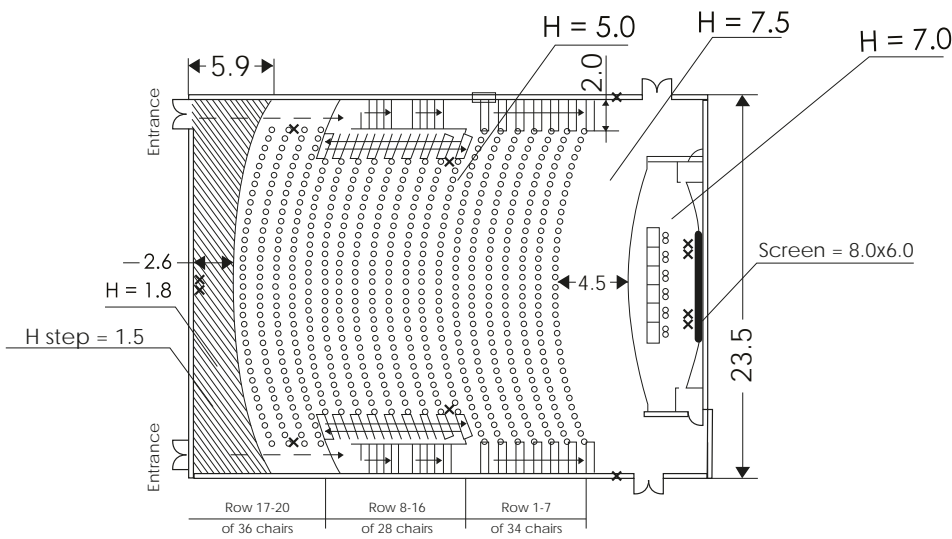

Seating capacity – 600
 S = 775 m²

Presidium table – 1.49 x 0.75 x 0.74 (L x W x H)
 x – 220 V sockets location

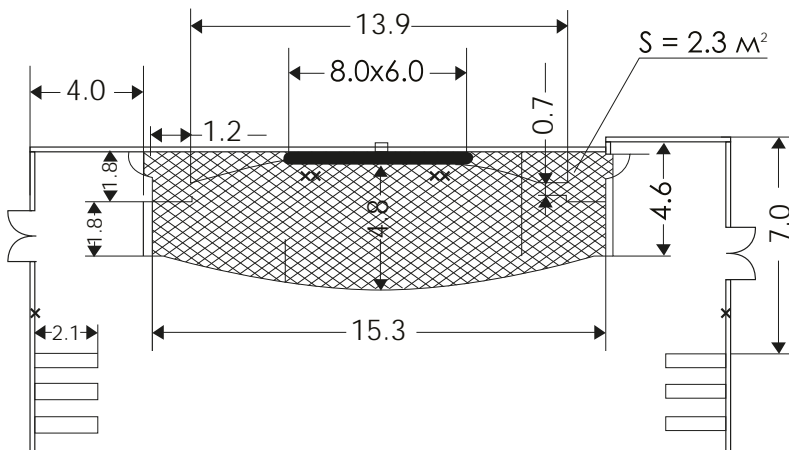

Podium layout conference hall Blue

x – 220 V sockets location

Meeting rooms layout and specification, Pavilion 2

Meeting room 5

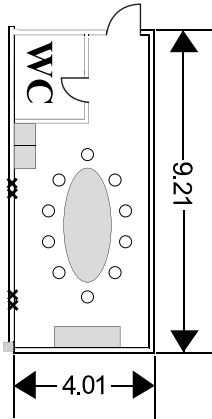

Seating capacity – 10
S = 30 m²

Ceiling height – 3.88 m
x – 220 V sockets location

Meeting room 6

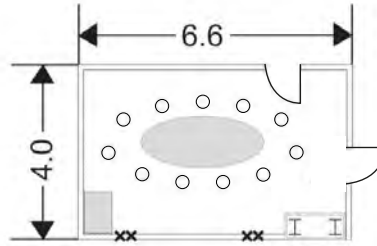

Seating capacity – 10
S = 24.8 m²

Ceiling height – 3.88 m
x – 220 V sockets location

Meeting room 7

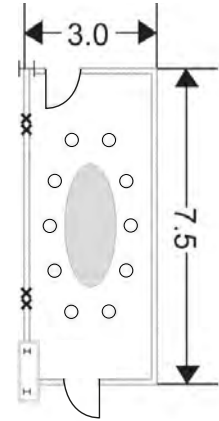

Seating capacity – 10
S = 22 m²

Ceiling height – 3.88 m
x – 220 V sockets location

Meeting room 8

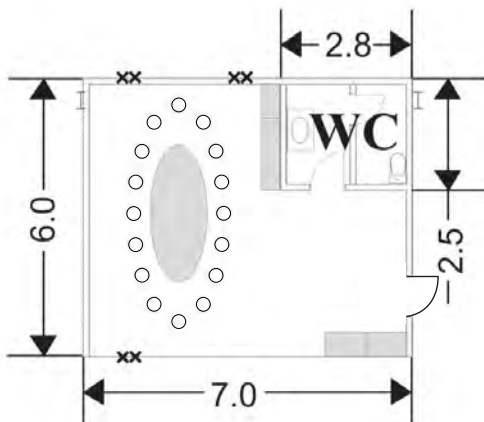

Seating capacity – 16
S = 35.8 m²

Ceiling height – 3.88 m
x – 220 V sockets location

Meeting room 9

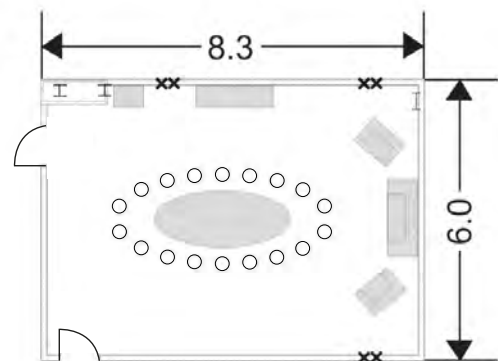

Seating capacity – 18
S = 49 m²

Ceiling height – 3.88 m
x – 220 V sockets location

Significant events



Russian oncological congress

The largest national oncological event in Russia. The congress is held by the Russian society of clinical oncology (RUSSCO) and the Russian Society of Clinical Oncology named after N.N. Blokhin under the auspices of the Russian Association of Oncologists. The program features speeches by leading national and foreign experts who cover in their reports the main achievements in diagnosis and treatment of malignant tumors over the last year.



Significant events



Educational event with international participation National Congress of Therapists

The program covers the widest possible range of issues of diagnosis, prevention and treatment of internal diseases. A competition of young therapists, focused on the support and development of the generation of young doctors in Russia is held as part of the scientific program.

National veterinary conference NVC

The largest annual veterinary conference in Russia and Eastern Europe which gathers on the same platform the best Russian and foreign veterinary specialists, top managers and employees of the leading veterinary clinics.



Significant events



Forum of innovative financial technologies FINOPOLIS

The largest in Russia platform for discussion and analysis of trends and opportunities for the use of modern digital technologies in the financial sector. The forum is held by the Bank of Russia in partnership with IT and financial market leaders.

The largest professional conference for developers of high-load systems Highload ++

The leading IT professionals of the country gather annually on the same platform to share knowledge about technologies of high-performance systems that can serve millions of users simultaneously.



Significant events



Business forum 1C:ERP

The purpose of the forum is to exchange experience in the implementation projects 1C: ERP, 1C: Corporation, 1C: Holding Management, 1C:ERP Holding Management, 1C: CORP Document Management, 1C: CORP HRM & Payroll, 1C: Analytics and other 1C solutions for the corporate sector, presentation of new capabilities of these solutions and the 1C: Enterprise platform, 1C services, industry and specialized 1C-Joint solutions.

Cup of the Prosecutor General of the Russian Federation

The All-Russian competitions in classic sport and compound bows. A great competition week filled with bright sports moments, honest rivalry and personal triumphs of young athletes.



Contacts

Department of non-exhibition and congress events

Head of Administrative Board

Tatiana Volnina

Phone: +7 (495) 727-2593

Mobile phone: +7 (985) 924-1624

E-mail: T.Volnina@Crocus-Expo.ru

Deputy Department Director

Galina Melentieva

Phone: +7 (495) 727-2593

Mobile phone: +7 (916) 119-8397

E-mail: G.Melenteva@Crocus-Expo.ru

Deputy Department Director

Daria Alpatova

Phone: +7 (495) 727-2593

Mobile phone: +7 (985) 762-4336

E-mail: D.Alpatova@Crocus-Expo.ru

Senior Manager

Arturs Kleshniks

Phone: +7 (495) 727-2591

Mobile phone: +7 (977) 523-5718

E-mail: Kleshniks@Crocus-Expo.ru

Senior Manager

Svetlana Tikhovskaya

Phone: +7 (495) 727-2591

Mobile phone: +7 (985) 366-2637

E-mail: Tihovskaja@Crocus-Expo.ru